

The Simulation & Analysis Platform for NDT



CIVA is the expertise platform which includes modeling plus imaging and analysis tools, assisting in the design and optimization of inspection methods and the prediction of their performances for realistic configurations.



CIVA simulates Ultrasonic Testing (UT), Guided Wave Testing (GWT), Eddy current Testing (ET), Radiographic Testing (RT) and Computed Tomography (CT).

CIVA UT

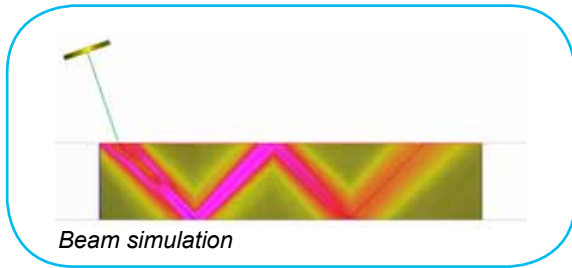

Many capabilities to simulate realistic NDE situations:
CIVA Ultrasound gives you the ability to simulate the whole inspection process (**pulse echo, tandem or TOFD**) with a wide range of probes (**conventional, Phased-arrays or EMAT**), components (from simple shapes to complex 3D CAD geometries), and defects (calibration holes, planar defects, crack like defects, volume flaws, even inclusions). The component can be homogeneous or made of several parts or several layers (e.g. cladding). Materials available are not only **metallic** ones but can also be, for instance, **fiber composites** or granular composites (e.g. concrete).

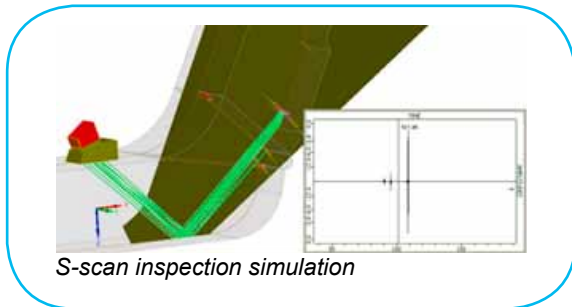

Innovate with Phased-Arrays probes:
CIVA includes sufficient features to design PA probes and simulate **classical and advanced PA settings** (from single sequence to electronic scanning, specific algorithms available such as Total Focusing Method and SAUL). CIVA includes a **delay law calculator** (to define focusing, sector scanning, etc.) from which you can export the computed data (focal laws and index points).

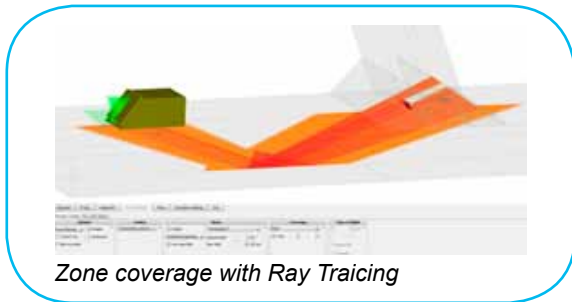

Shift up a gear with CIVA:
Thanks to its dedicated environment and a lot of configurations “ready to define”, to create a configuration in CIVA is a matter of minutes, if not seconds! Mostly based on semi-analytical models, CIVA simulations are also intrinsically **fast** which opens the door to intensive parametric studies.

UT simulation tools include:

- **“Beam computation”:**
Ultrasound Beam propagation simulation (flaw free configurations)
- **“Inspection Simulation”:**
Predicts echoes from beam interaction with defects or specimen boundaries

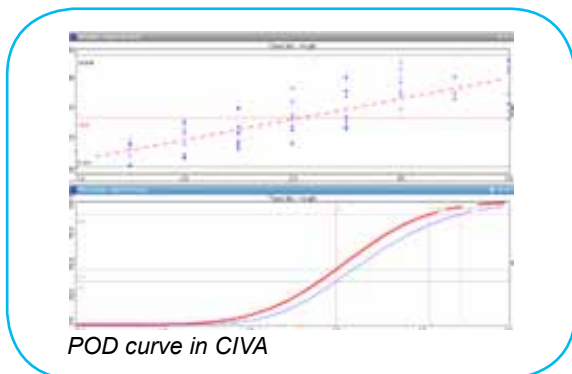

The calculation can account for **multiple skips** in the component and **mode conversions** with Longitudinal and Shear waves. An advanced **ray tracer** is connected to the CIVA simulation modules. It displays the different wave modes propagated and reflected, and can help **evaluate at a glance the covered area** with the defined settings for a given scan plan. Results are provided as classical UT data (**A-Scan, Echodynamic curves**) or more advanced images (**B-Scan, C-Scan, S-Scan, E-Scan, etc.**) that can be **reconstructed in the 3D view** and superimposed on the work piece, facilitating an optimal understanding of physical phenomena. All analysis features available to process acquisition data (described on the next pages) are also available for simulation results. **POD** calculations (Probability Of Detection) can also be performed, based on accounting for uncertain input parameters.

Discover more about the UT module at
<http://www.extende.com/ultrasonic-testing-with-civa>

CIVA 2017 – UT MODULE Features list



Available in
English,
French and
and Chinese

Basic features

- Parametric geometries (planar, cylindrical, spherical, conical), 2D CAD editor
- Isotropic materials (with database), attenuation laws
- Industrial probe library
- Conventional UT probe descriptors (immersion, contact, straight beam, angle beam) with several crystal shapes (rectangular, cylindrical, elliptical)
- Dual Element Probe, TOFD, 1D Array probes (linear & annular arrays)
- Planar defects, calibration holes (FBH, SDH, etc.), spherical porosities and inclusions
- 1D and 2D (raster) scanning
- Beam computation and inspection simulation
- Ray tracing (zone coverage)
- Bulk wave computations (Longitudinal, Shear Waves)
- 2D and 3D computation

Advanced features

- Heterogeneous and multi layered structures
- Weld and nozzle geometries with templates
- 3D CAD import
- Anisotropy, Structural noise, Polycrystalline model, Composite model
- Focused probes
- Tandem
- 2D advanced PA probes (Matrix, Dual Matrix Array, TRL, Sectorial, Flexible and even...custom!)
- EMAT probes (single and multi-elements)
- Advanced Delay law calculator (beam focusing, beam steering, sectorial scanning, multi shots, dynamic delay laws)
- Advanced PA settings (electronic scanning, FMC-TFM, PWI-TFM, ATFM, SAUL, DDF)
- CAD-contour and branched defect profiles
- Multi-skip Inspection Simulation
- Complex and robotic scanning patterns
- Geometrical echoes computation
- Mode conversions
- Modes identification
- Parametric studies (variation over one or more parameters) and sensitivity studies with metamodels
- PoD computation

Analysis features

- All features of CIVA UT analysis! See details p5

Optional features

- CIVA ATHENA2D (coupling CIVA and ATHENA2D FEM simulation from EDF)
- CIVA FIDEL2D (coupling CIVA and the Finite Difference code FIDEL from AIRBUS GROUP Innovations for advanced composite simulations)

CIVA UT ANALYSIS

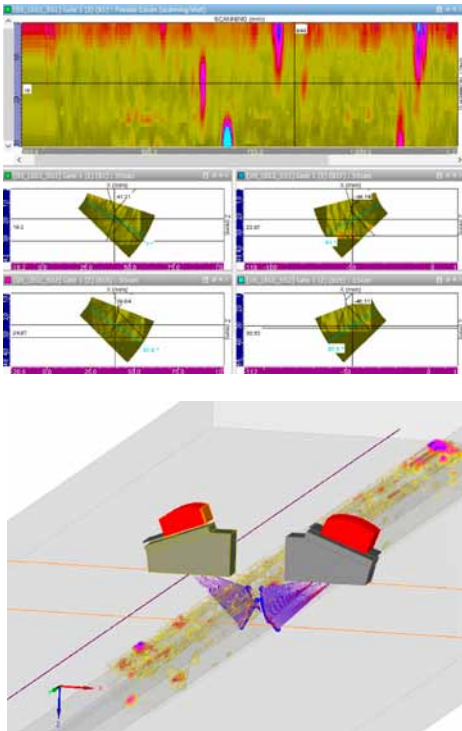

Analysis toolbar, Multi-Channel acquisition data displayed in 3D view

Display acquisition data in 3D:

Data is displayed as **classical UT data** (A-Scan, Echodynamic curves) or more **advanced images** (B-Scan, C-Scan, S-Scan, E-Scan, etc.). Connected with a description of the acquisition parameters (component, probe, scanning, etc.), data can be displayed in the **specimen frame** and **exported in the 3D view** with the “**one click 3D view**” which provides a quick and easy understanding of the indication’s location.

Fast, efficient and customizable analysis:

Within a user-friendly environment offering a complete toolbar, you can easily and quickly extract interesting information thanks to the graphical definition of a custom region of interest (ROI) from which **one-click tools** such as “**-xdB contour**” or **Segmentation** help to analyze the signal (amplitude, position of detection, time of flight) then **locate & size indications**. Segmentation even makes groups **automatically visible in the 3D display**. You can **customize** your use of CIVA UT Analysis to drastically reduce repeatable actions, have a convenient environment, and **automate most of your analysis procedure** ! Give a name to some of the actions you currently do and recall it for a similar file to have a consistent process, avoid errors, save time and put your efforts on the real work of analysis!

Relevant information (amplitude, position, size...) is included in an **indication table** in one click. Columns of this indication table can be selected and sorted among a complete list of available data. In one click, this indication table can be **exported in CSV format** or as an **HTML report**.

Advanced analysis tools link with simulation tools:

To help with the diagnosis, multiple functionalities are available: a wide range of **signal processing methods** (classical such as filters or advanced options). If you use the latest techniques like **TFM** (total focusing method), you can make appropriate reconstructions and even redraw the surface of your specimen in one click. You can also benefit from simulation tools in CIVA UT to easily compare your simulation and acquisition data on the same page for assessment. Even if you do not have the UT simulation module of CIVA, CIVA UT Analysis offers a “**simulation on acquisition**” feature, based on the prediction you want to test (planar defect) to confirm or disprove a conclusion by simulation of a given Region of Interest.

Beam Calculation and Delay laws export (optional):

It is possible to include in your CIVA UT analysis package, the **beam computation** module of CIVA (simulation), described in the previous part. With this option, you will be able to **load and compare simulation files with acquisition files**. The **delay laws calculator** also provides the possibility to export in *.raw and *.pte ASCII files both delay laws and index point’s data.



Compatible with M2M and Olympus equipments

Discover more about the UT analysis module at
<http://www.extende.com/ultrasonic-testing-analysis-with-civa>

CIVA 2017 – UT ANALYSIS MODULE

Features list



Available in
English,
French and
and Chinese

Basic features

- Classical images (A-Scan, B-Scan, C-Scan, D-Scan...)
- PA Images (S-Scan, E-Scan...)
- 2D scan images superimposed onto the 3D part
- Specimen reconstruction (from simple to 3D CAD specimen)
- Amplitude measurement & calibration
- Distance measurement (3D), surface measurement
- TOFD Calibration, lateral wave linearization and deletion
- Report in HTML or export as CSV
- Delay laws calculator (includes management of electronic scanning)
- Display in amplitude, depth or time of flight

Advanced features

- Reconstruction with material and geometrical influences
- Multi-channel data files with data merging
- Hysteresis correction
- 3D evolved ray tracer with time of flight connection
- Layout definition and back-up
- DATA Eraser
- Complete traceability of actions modifying data
- Acquisition gates addition, modification and synchronization
- One-click amplitude histogram with mean values, max...
- “-x dB” automatic contour (Also added in report)
- Signal processing (filters to wavelets or split spectrum...)
- TCG (Time Corrected Gain)

Cutting edge features

- One-click segmentation with 3D representation
- One-click 3D full DATA export
- UT Simulation on defects in a ROI
- Customization of report column, environment, thresholds, recording of analysis operators, templates for most processing with naming and back-up
- Automation of analysis procedures
- TFM reconstructions and surface reconstruction

Optional features

- UT Beam simulation
- Load CIVA inspection simulation files in the analysis environment
- Delay Laws export
- Accepted format: M2M systems, Gekko, Olympus Data (need Library), Plug In proposed to load other data file formats and customize analysis tools

CIVA GWT

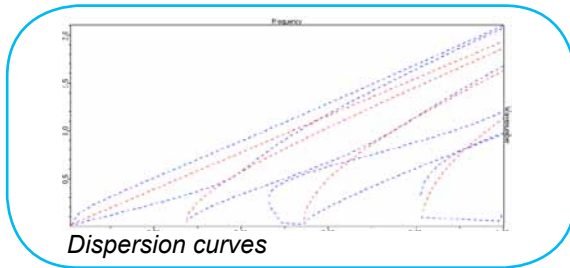

Echo computations with Guided Wave testing:

CIVA Guided Wave Testing computes the echoes obtained from **flaws** or geometrical changes (perpendicular to the inspection direction). Parametric discontinuities are available (**groove, section transition or weld**) but it is also possible to **draw a junction or a complex profile in the 2D CAD editor of CIVA**.

Dispersion curves in many component geometries, from simple to complex profiles:

A 2D CAD editor lets you define a **2D CAD profile** for which CIVA GWT is able to compute the dispersion curves, beam radiated by a probe and inspection simulation. This editor is useful in order to determine the modes propagating in a rail for example.

A large variety of probes taken into account:

The Inspection Simulation and Beam Computation modules consider a large range of probes. **Piezo-electric** and **magnetostrictive probe types** can be easily modelled, including the solicitation direction. Piezo-electric probes with **wedges** can be also simulated. Thanks to a coupling with CIVA ET modeling, CIVA GWT can also simulate **EMAT probes**.

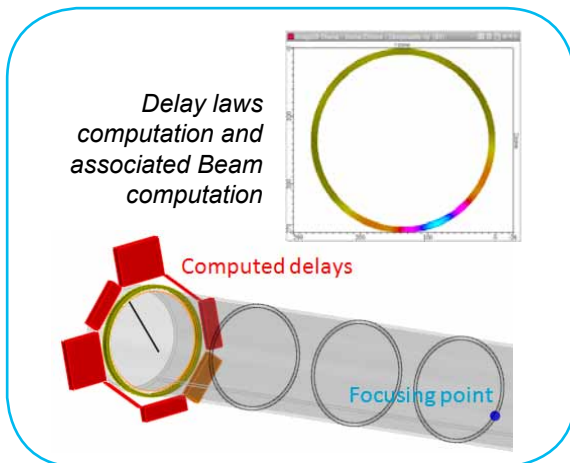

Delay laws computation:

In the case of phased-array annular probes **on pipes**, the delay laws can be calculated in CIVA (for a probe center frequency lower than the cut-off frequency of the third involved mode).

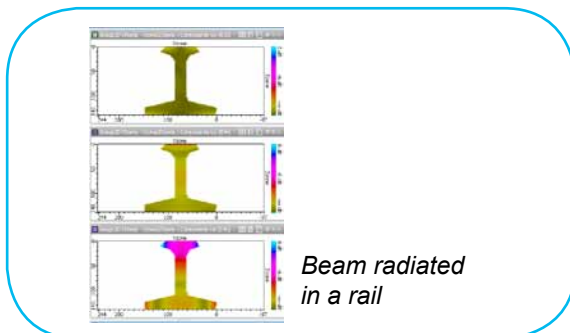

GWT simulation tools include:

- **“Modes computation”**: Dispersion curves computation on plates, pipes or 2D CAD profile in 3D
- **“Beam computation”**: Computation of the modes radiated by a probe and field profile (energy distribution among modes, displacement and stress map over the profile)
- **“Inspection Simulation”**: Defect and/or Geometrical discontinuity response simulation

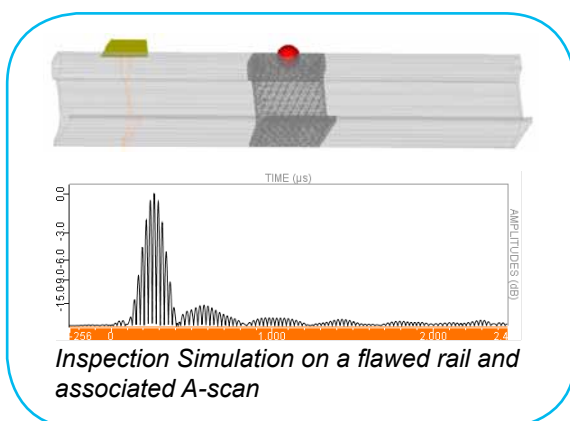

The modes computation offers a view of the modes that may propagate in the structure. The stresses and displacements associated with each mode are displayed in the specimen section. The beam computation displays the beam radiated by a probe in a structure and the energy distribution among the different modes that may propagate. The inspection simulation estimates the A-scan obtained.

Discover more about the GWT module at

<http://www.extende.com/guided-wave-testing-with-civa>

CIVA 2017 – GWT modeling Features list



Available in
English,
French and
and Chinese

Basic features

- Dispersion curves computation on plates and pipes (phase velocity, group velocity, wavenumber, wavelength)
- Modes computation in 2D and 3D (Symmetric modes, antisymmetric modes, SH mode, Longitudinal mode, Torsional mode, Flexural mode)
- Computation of the beam radiated by a probe including:
 - energy distribution between the modes
 - displacement color chart in the profile
 - stress color chart in the profile
- Beam computation for single-element probe
- Beam computation on a pipe with array of annular probes
- Attenuation associated with a guided mode
- Piezo-electric and magnetostrictive probes with a selected solicitation direction

Advanced features

- Homogeneous or multilayered plates
- Coatings
- Pipes filled with fluid
- Dispersion curves for 2D CAD profiles
- Beam computation for phased-array probe
- Delay laws computation in pipes (for probe center frequency lower than the cut-off frequency of the third involved mode)
- EMAT probe simulation
- Defect response computation of transverse defect in planar & cylindrical specimen geometries
- Defect response computation of transverse defect (rectangular or semi elliptical section) in groove, weld, section transition and 2D CAD junction component geometries
- Defect response computation in a 2D CAD profile (such as rail) for:
 - planar rectangular flaw
 - semi-elliptical flaw
 - planar CAD contoured flaw
 - branched crack
 - rectangular block
 - cylindrical, spherical or elliptical volumetric flaw
 - 3D CAD flaw
- Geometrical change echo computation on groove, weld, section transition and 2D CAD junction
- Pulse-Echo or Pitch-Catch mode (transmission or reflection)
- Parametric studies (variation over 1 or more parameters)

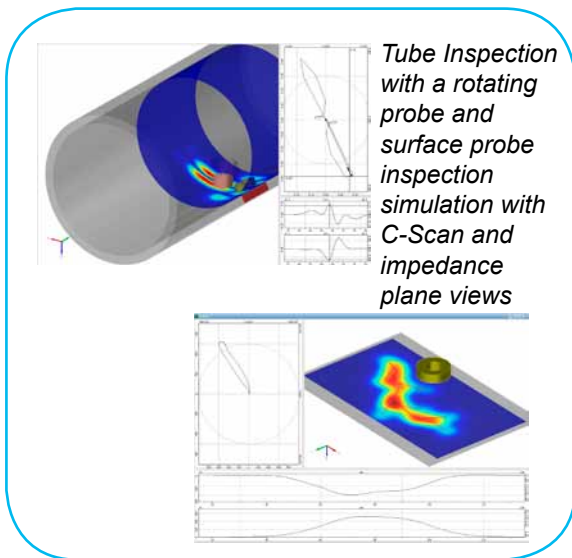
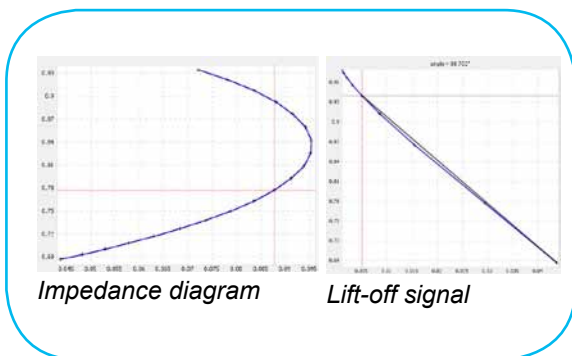
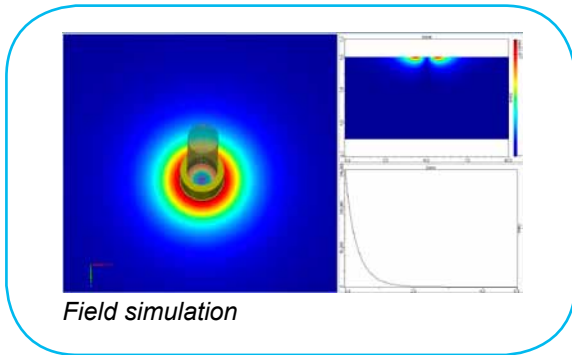

Easy and fast simulations of tube and surface inspections:

CIVA Eddy Current offers a dedicated environment to easily and quickly simulate typical inspection setups for **planar surfaces and tube inspection** configurations including various types of defects (Longitudinal or transverse notches, grooves, holes, semi or quarter elliptical flaws, fretting wear). Surface inspection of **fastened plates** (including rivets) can also be defined. With coaxial probes, tube inspection can include external elements such as a parasitic **deposit** or a **support plate**, or an expanded part, typical of **Steam Generator inspection issues**.

Variety of Eddy Current probes and techniques available:

CIVA includes an extensive library of probe types such as conventional surface probes with **various coils shapes** (cylindrical, rectangular, spiral, racetrack, meander, D) and also advanced sensors such as **Eddy Current arrays** or **orthogonal wound arrays** (“+Point like design”). For tube inspections, in addition to **conventional bobbin or encircling coils**, **rotating probes** with one or several elements can be created, including the “Rototest” probe design commonly used for bore inspections. Sectorial coils are also available as well as the X-probe like sensor. Ferrite cores of various shapes (cylindrical core, cap, U-Yoke) can be defined, a shielding ring can be also included. Specific set up using **GMR** like sensors (Giant Magneto Resistance) can also be simulated as well as the **Remote Field Testing** technique for ferromagnetic tube inspections. **Pulsed Eddy Current** is also now available

Multi channels simulation:

CIVA lets you simulate several acquisition modes in a single file: absolute or differential reception modes, double function or separate *transmit/receive* modes, single or several frequencies.

ET simulation tools include:

- **“Field computation”**: Electromagnetic field and eddy current distribution (flaw free configurations)
- **“Impedance and lift-off diagram”** plotting
- **“Inspection Simulation”**: Defect response simulation (impedance variation signal)

The field simulation tool provides access to a precise evaluation of the action zone and eddy current penetration with a given probe while impedance and lift-off diagrams helps to define operating settings (frequency, calibration, etc.). The inspection simulation module can predict the signal response with different types of outputs: **C-scan views**, **impedance plane** curves, X/Y “temporal” channels (or Real/Imaginary part) Amplitude/Phase. **POD** calculations (Probability Of Detection) can also be performed, based on accounting of uncertain input parameters.

Discover more about the ET module at <http://www.extende.com/eddy-current-testing-with-civa>

CIVA 2017 – ET MODULE Features list



Available in
English,
French and
and Chinese

Basic features

- Parametric geometries (planar, cylindrical)
- Conductive materials (with database)
- Conventional surface probes editor (with various shapes)
- Ferrite core (Cylindrical core, C and E pot, U-Yoke)
- Tube inspection probes (bobbin coil, encircling coil, sectorial coil, rotating coil)
- Notch defects (longitudinal, transverse) with rectangular, semi or quarter-elliptical shape, Flat Bottom holes, Grooves
- 1D and 2D (raster) scanning
- Field calculation and inspection simulation
- Impedance diagram vs frequency
- Lift-off signal computation
- 2D axisymmetric and 3D computations
- Multi-channel simulation with different operating modes (absolute, differential, double function or separated Transmit/Receive) and frequencies

Advanced features

- Multi-layer planar configurations with/without rivet
- Multilayer tubular axisymmetric configuration with coaxial probes
- 2D CAD editor for complex axisymmetric configuration with coaxial probes
- Linear ferromagnetic properties in tubular configurations
- Remote Field Testing
- Eddy Current Arrays (surface probes), X-Probe like sensor (in tubes)
- Orthogonal wound probe (+Point like design with ferrite core)
- Rototest like probe (with D shape ferrite pot)
- EMAT probes (single and multi-elements) for coupling with CIVA UT
- GMR (Giant Magneto Resistance)
- Pulsed Eddy Current
- Electrical parameters of ET system (generator, cable, probes)
- Fretting wear defect in tubes
- Parametric studies (variation over 1 or more parameters) and sensitivity studies with metamodels, POD studies

Analysis features

- C-Scan image and export to 3D view
- Impedance plane curves
- X/Y channels curves
- Amplitude/Phase curves
- Calibration
- Balancing
- Amplitude/Phase Automatic measurement
- Result comparison tools
- Frequency Mixing

CIVA RT - CT

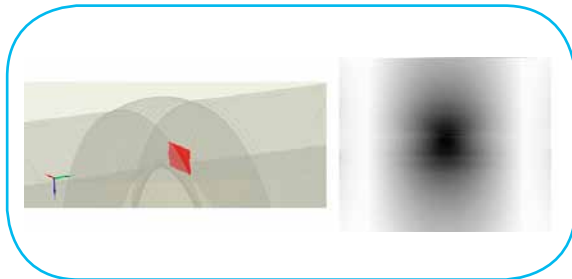

Direct and scattering radiation modelled in one single simulation:

The CIVA RT simulation module lets you simulate a full radiographic inspection by taking into account the radiation produced by X-ray, gamma ray and high energy sources.

CIVA RT can predict images related to standard **films, flat panel detectors, image plates**...with a wide range of components (including 3D CAD geometries), and defects (rectangular defects, crack like defects, inclusions, porosities and even 3D CAD flaws).

In addition to these options and in order to be as close as possible to real radiographic shots, a standard library of **IQI** is proposed (wire type, double wire, plaque penetrameters...). The IQI can be positioned from the source or film side. The component can be homogeneous or **heterogeneous** (made of several parts or several layers). The material is defined from an available database including more than **110 elements and alloys**, with the associated cross-section data.

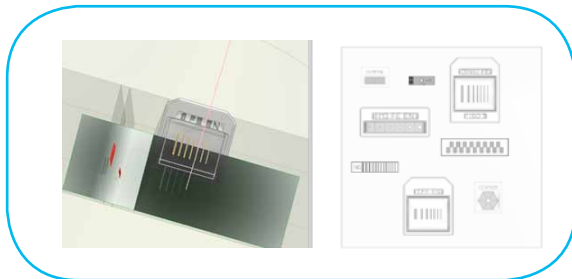

Backscattering effects can also be accounted for in order to evaluate the impact of the environment on the darkening of the detector.

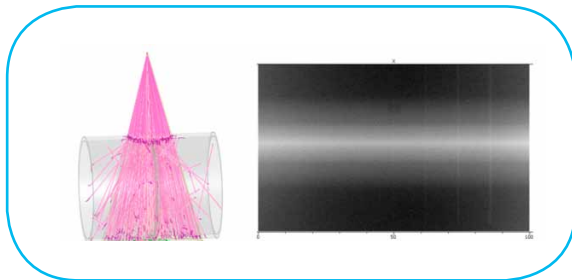

A quick set-up, a lot of results:

From the simplicity of the CIVA interface, the user can easily and quickly set-up their configuration: Selection of the part to be inspected, definition and positioning of the source and the detector, insertion of one or several flaws, definition of calculation options. Users can visualize the detector responses (**optical density or gray levels**) as well as the incident dose in Gray or the deposited energy on the detector in keV. Results are presented as images in the classical CIVA. Detectability criteria are integrated in CIVA in order to provide with automatic detectability threshold based on a signal to noise ratio and comparison between images with flaw and without flaw.

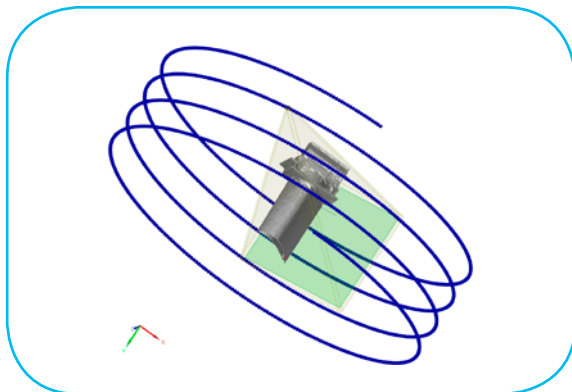

Reconstruction of simulated and experimental tomographic data:

CIVA lets you **simulate computed radiography** and also to **import real data** that can be further processed and reconstructed using the available algorithms: **FDK** (analytic), **PixTV** (iterative) or **SART** (complex CT scan).

CIVA CT is a simulation tool for a realistic modeling of the X-ray image formation including photon attenuation and scattering processes and the modeling of various X-ray sources and detectors.

In order to perform a CT reconstruction, an arbitrary number of steps and shot positions must be defined. Then, CIVA will run the RT simulation for all the projections. It includes the simulation of **circular, helical or complex** and robotic trajectories.

Discover more about the RT module at

<http://www.extende.com/radiographic-testing-with-civa>

Discover more about the CT module at

<http://www.extende.com/computed-tomography-with-civa>

CIVA 2017 – RT-CT Modeling Features list



Available in
English,
French and
and Chinese

Basic features

- Calculation of the direct radiation
- Basic images as “Optical density” or “grey level images”
- Library of parametric geometries of specimens
- X – γ – High energy sources
- Detectors: Films – CR – DR
- Export of images in Tiff and Raw format file
- Library of materials
- Library of parametric geometries of flaws
- Source blurring
- Detector’s noise
- Library of IQI

Advanced features

- Calculation of the scattered radiation
- Import of 3D CAD files
- Possibility to create alloys
- Build-Up image
- Possibility to take into account the global FTM blurring
- Possibility to realize a parametric study
- Post-Processing
- Detectability criteria

In the case of the purchase of the CT Module:

- Circular tomographic scanning
- Reconstruction with FDK or PixTV algorithm for circular scanning

Cutting edge features

- Detectability criteria
- POD
- Back scattering radiation can be modeled
- Possibility to realize a short scan

In the case of the purchase of the CT Module:

- Possibility to realize a short scan
- Helical tomographic scanning
- Reconstruction with FDK algorithm for helical scanning
- Complex/Robotic tomographic scanning
- Reconstruction with SART algorithm for complex scanning
- Reconstruction with PixTV algorithm for circular scanning
- Reconstruction parallelized on GPU

Optional features

- CT module

HARDWARE & SOFTWARE REQUIREMENTS

Minimal configuration*:

- 64 bits OS == Windows 7 / Windows 8 / Windows 8.1 / Windows 10
- Dual core
- Ram : Minimum ≥ 8Go, Recommended ≥ 16Go
- Hard Disk ≥ 250 Gb
- Graphic Resolution == 1280 x 1024 or 1920 x 1080
- DVD ROM
- USB port for Hardware dongle (Software key is proposed by default)

*Windows XP and 32 bits OS are no longer supported (Windows XP is not supported any more by Microsoft).

Optimized configuration**:

- 64 bits OS == Windows 7 / Windows 8 / Windows 8.1 / Windows 10
- Hexa / Octo core
- Ram ≥ 24 Gb
- Hard Disk ≥ 500 Gb (with CIVA installed on SSD system disk 256 Gb):
 - o All disks (data and system) on SSD for CIVA UT Analysis
- Graphic Resolution == 1920 x 1200
 - o Dedicated graphic card if computer is a laptop
- DVD ROM
- USB port for Hardware dongle (Software key is proposed by default)
- GPU Graphic Processor (useful for CIVA CT only) with compute capability version ≥ 2.x

(http://en.wikipedia.org/wiki/CUDA#Supported_GPUs)
For instance == GTX1080 Ti or Quadro P4000

** An efficient use of CIVA CT requires this optimal configuration



We are certified ISO 9001 and ISO 14001



and we signed the Global Compact



EXTENDE
14 Avenue Carnot
91300 Massy
FRANCE

EXTENDE Inc.
PO Box 461
Ballston Spa
U.S.A.

155 Cours Berriat CS70022
38028 Grenoble
FRANCE

Follow us



License